



Courtesy: Supercare Hospital, Shillong

# HOSPITAL UTILITY SOLUTIONS



## Introduction

Medimek's customized made-to-order furniture is designed to meet your various requirements. Our offerings of various solutions make us a one stop shop for your needs. We start by carefully assessing the space and include you in the design process. Our innovative metal designs, attractive appearance are high quality and long lasting. Office desks, reception counters, nursing counters, storage systems, staff lockers, pharmacy setup are some of our varied offerings.

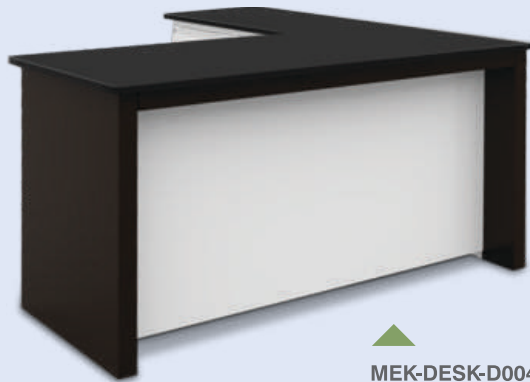

MEK-DESK-D0040

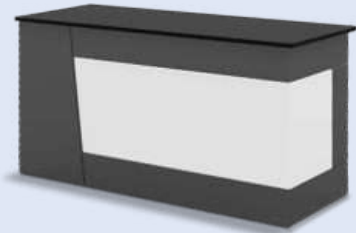

MEK-DESK-D0020



MEK-DESK-D0010

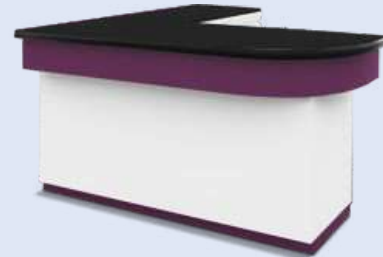

MEK-DESK-D0030



**Desks & Workspaces**

Stylish looking steel construction making it long lasting, pest-resistant and fire-resistant.

## Reception Counters

Eye catching design offering great form and comfort personalized branding.



MEK-COUNTER- D0010

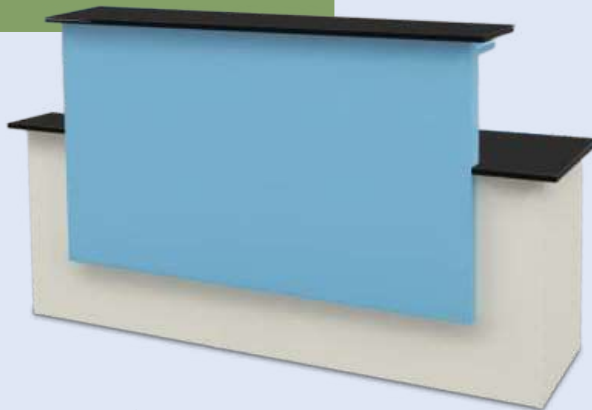

MEK-COUNTER - D0020

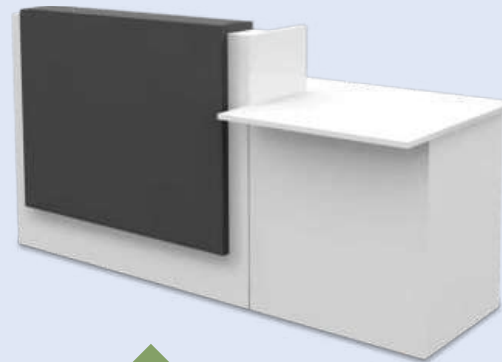

MEK-COUNTER - D0030



MEK-COUNTER - D0040



▲  
MEK-COUNTER - D0050



▲  
MEK-COUNTER - D0060



▲  
MEK-COUNTER - D0070

## Nursing Stations

Nursing stations that offers a 360 degree view of the environment for the care giver. Also, improving nurse ability to focus and collaborate with teammates.

## Pedestal

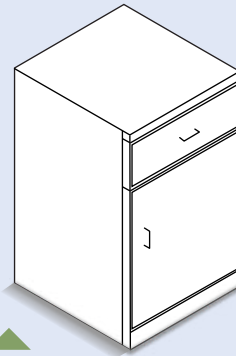

PEDESTAL : 1 DRAWER 1 SHUTTER

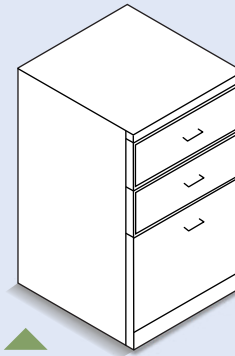

PEDESTAL : 3 DRAWERS

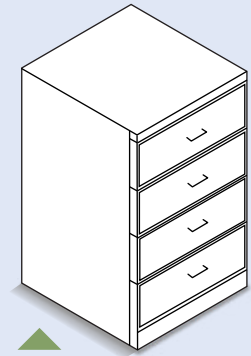

PEDESTAL : 4 DRAWERS

## Side storage unit

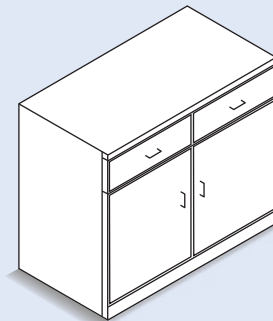

SIDE STORAGE : 2 DRAWERS  
2 SHUTTERS

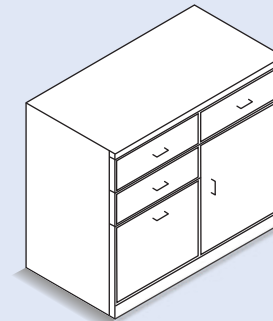

SIDE STORAGE : 4 DRAWERS  
1 SHUTTER

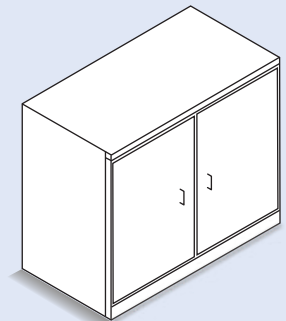

SIDE STORAGE : 2 SHUTTERS

## Back Storage + Wall mounted cabinet

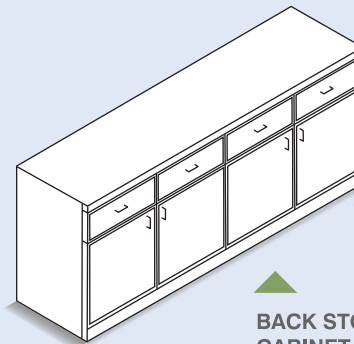

BACK STORAGE :  
CABINET

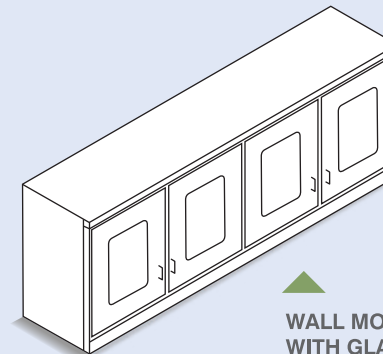

WALL MOUNTED CABINET  
WITH GLASS DOOR





▲  
KEY BOARD TRAY



▲  
CPU STAND ON WHEELS



▲  
CABLE MANAGER



▲  
ELECTRICAL TRUNKING



▲  
INBUILT SWITCHES, SOCKETS,  
LAN AND TELEPHONE CONNECTIONS

## Accessories



▲  
GRANITE TABLE-TOP



▲  
BACK PAINTED TABLE-TOP



▲  
LAMINATED PLY TABLE-TOP

## Table Top Options

## Bunk Beds & Staff Lockers

Material of Construction : Mild steel  
CRCA Sheet and ERW Tubes



BUNK BED WITHOUT STORAGE



BUNK BED WITH STORAGE



STAFF LOCKER  
WITH SHOE SHELF



STAFF LOCKER



STAFF LOCKER  
WITH HANGER ROD





CATHETER STORAGE



STENT STORAGE CABINET



MS SCOPE CABINET



STENT STORAGE CABINET WITH DRAWERS



SS SCOPE CABINET



MS MANOMETRY TROLLEY

## Cath Labs & Endoscopy unit furniture

Material of Construction : Mild steel  
CRCA Sheet and ERW Tubes  
Stainless Steel - 304 grade



CSSD : CONTROL AND  
PACKAGING TABLE



CSSD : WORKTABLE WITH  
TWO WASHING TRAYS



CSSD : WORKTABLE

## CSSD Labs

Material of Construction :  
Stainless Steel - 304 grade



CSSD : DRUM TROLLEY



CSSD : INSTRUMENT STAND



CSSD : WORKTABLE WITH  
UNDER STORAGE CABINETS

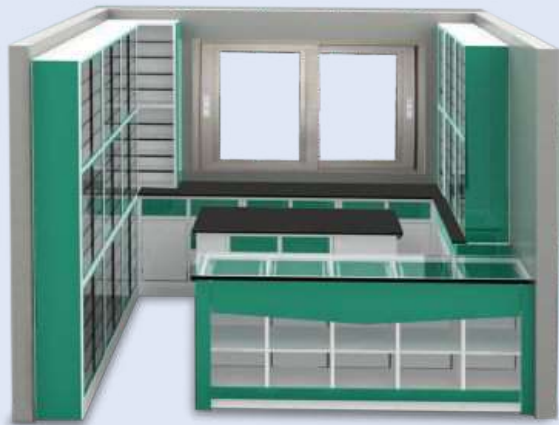

▲  
**PHARMACY : RACK WITH  
 GLASS SHELVES AND  
 SLIDING GLASS DOORS**



▲  
**PHARMACY : RACK WITH GLASS  
 SHELVES+DRAWERS + SHUTTERS**

## Pharmacy : Store Racks and Counters

**Material of Construction :**  
 Mild steel CRCA Sheet  
 and ERW Tubes



▲  
**PHARMACY : OPEN RACK  
 WITH SHELVES**



▲  
**PHARMACY : RACK  
 WITH SLIDING GLASS  
 DOORS + DRAWERS**



▲  
**PHARMACY : ISLAND TABLE WITH  
 DRAWERS + KNEE SPACE**



▲  
**PHARMACY : MAIN COUNTER WITH  
 DRAWERS + SHUTTERS**



Mi : 3052 TWO-SEATER PATIENT WAITING BENCH (37" LENGTH)  
 Mi : 3053 THREE-SEATER PATIENT WAITING BENCH (55" LENGTH)  
 Mi : 3054 FOUR-SEATER PATIENT WAITING BENCH (72" LENGTH)



Mi : 3057 TWO-SEATER LOUNGE SEATING (48" LENGTH)  
 Mi : 3056 THREE-SEATER LOUNGE SEATING (68" LENGTH)  
 Mi : 3058 FOUR-SEATER LOUNGE SEATING (94" LENGTH)

## Waiting Area Benches

**Material of Construction :**  
 Mild steel CRCA Sheet and ERW Tubes



Mi : 3057 A TWO-SEATER LOUNGE SEATING WITH CUSHION (48" LENGTH)  
 Mi : 3056 A THREE-SEATER LOUNGE SEATING WITH CUSHION (68" LENGTH)  
 Mi : 3058 A FOUR-SEATER LOUNGE SEATING WITH CUSHION (96" LENGTH)



▲  
**MI-6098**  
POLYMER SEAT  
STACKABLE CHAIR



▲  
**MI-6099 C**  
CUSHIONED SEAT  
STACKABLE CHAIR



▲  
**MI-6099 B**  
MEDIUM BACK CUSHIONED  
SEAT OFFICE CHAIR



▲  
**MI-6099 A**  
HIGH BACK CUSHIONED  
SEAT OFFICE CHAIR



▲  
**MI-6099 E**  
ERGONOMIC MESH HIGH  
BACK OFFICE CHAIR

## Chairs

## COLOR SCHEME

We offer an exciting array of powder coating color ranges that can match your interior theme. All CRCA surfaces undergo an 8 tank pretreatment process that provides excellent corrosion resistance

### WOODEN COLORS:



### SOLID COLORS:



### BASE FRAME COLORS:



## PRODUCT FEATURES

- Durable mild steel CRCA construction
- Pretreated and powder coated with epoxy paint
- Maintenance free soft closing hydraulic hinges
- Smooth drawer channels that sustain repeated operations
- High quality standard raw material
- Environment friendly with wooden effect aesthetics
- Customized designs with spectrum of vivid color schemes



## Quality Policy

Medimek is committed towards a common goal of achieving total customer delight by driving its mission statement through

- ✓ Continually innovating and improving products that are user friendly
- ✓ Optimizing the productivity by introducing useful inputs in our activities
  - ✓ Offering prompt and effective after sales service
  - ✓ Providing need based training to people





## **Medimek Industries**

**Manufacturer and Exporter of Patient and Utility Furniture**

---

Tel. : +91-251-2621124, 2621242 • Mobile : +91 8888200065 • Email : [info@medimek.com](mailto:info@medimek.com)  
B / 50 - 53 Additional MIDC, Anand Nagar, Ambernath [E] 421506, Dist. Thane, Maharashtra, India

**Certifications: ISO-9001 • ISO-14001 • ISO-13485 • ISO-45001 • ISO-50001 • CE Certificate**