

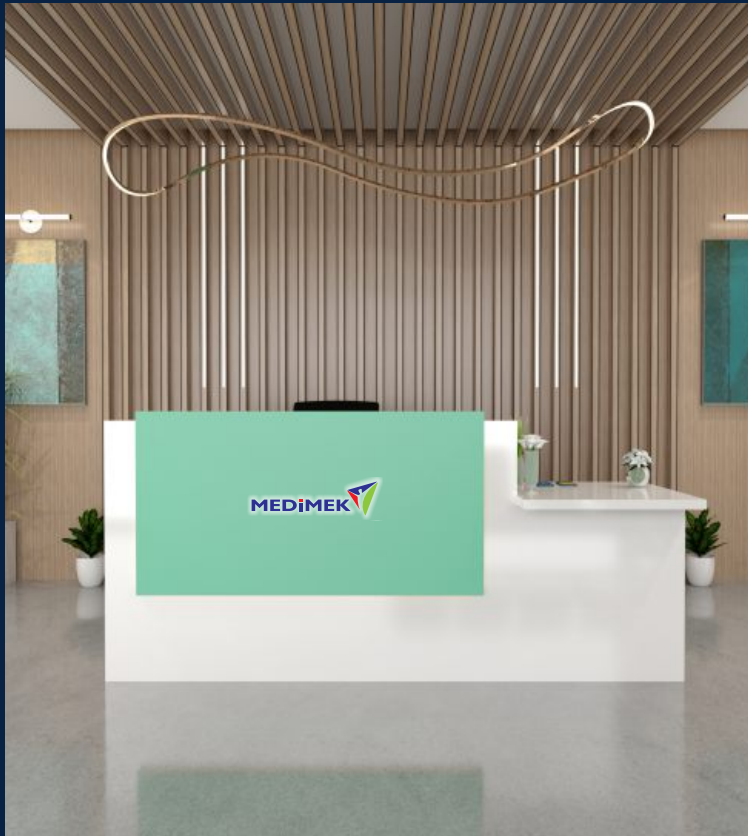

Courtesy: Supercare Hospital, Shillong

HOSPITAL UTILITY SOLUTIONS



Introduction

Medimek's customized made-to-order furniture is designed to meet your various requirements. Our offerings of various solutions make us a one stop shop for your needs. We start by carefully assessing the space and include you in the design process. Our innovative metal designs, attractive appearance are high quality and long lasting. Office desks, reception counters, nursing counters, storage systems, staff lockers, pharmacy setup are some of our varied offerings.

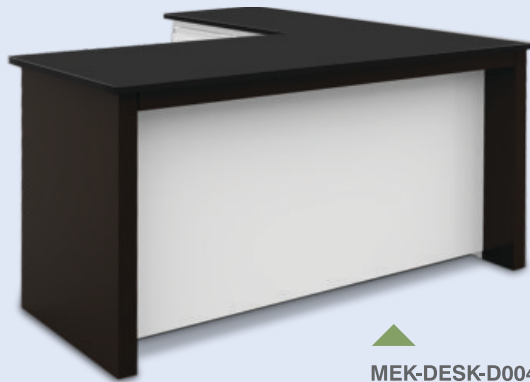

MEK-DESK-D0040

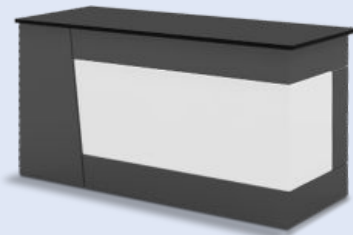

MEK-DESK-D0020



MEK-DESK-D0010

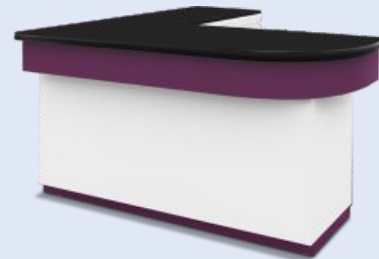

MEK-DESK-D0030

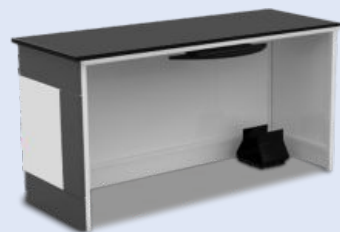

Desks & Workspaces

Stylish looking steel construction making it long lasting, pest-resistant and fire-resistant.

Reception Counters

Eye catching design offering great form and comfort personalized branding.



MEK-COUNTER- D0010

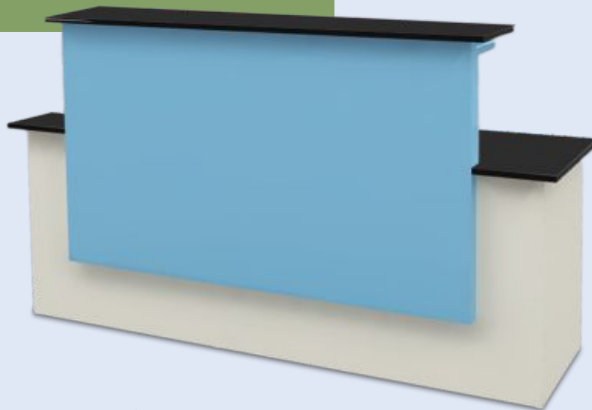

MEK-COUNTER - D0020

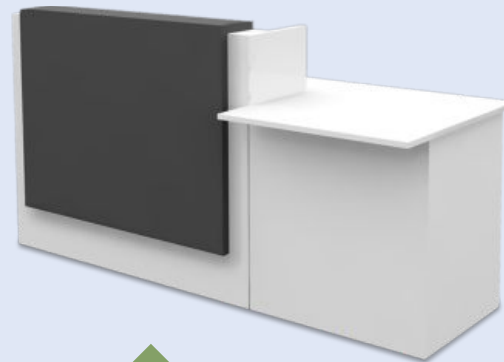

MEK-COUNTER - D0030



MEK-COUNTER - D0040



▲
MEK-COUNTER - D0050



▲
MEK-COUNTER - D0060



▲
MEK-COUNTER - D0070

Nursing Stations

Nursing stations that offers a 360 degree view of the environment for the care giver. Also, improving nurse ability to focus and collaborate with teammates.

Pedestal

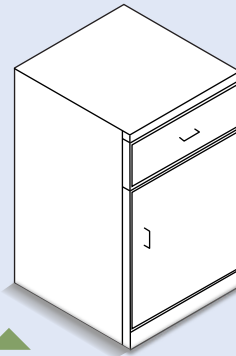

PEDESTAL : 1 DRAWER 1 SHUTTER

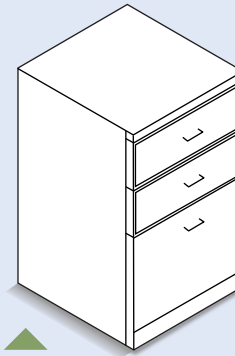

PEDESTAL : 3 DRAWERS

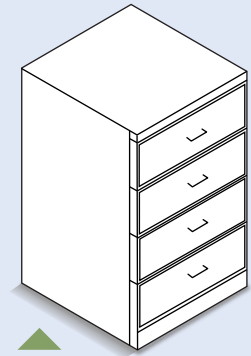

PEDESTAL : 4 DRAWERS

Side storage unit

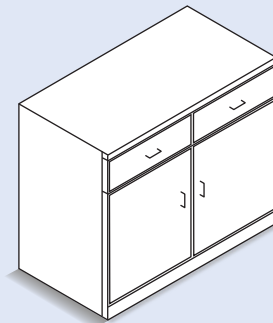

SIDE STORAGE : 2 DRAWERS
2 SHUTTERS

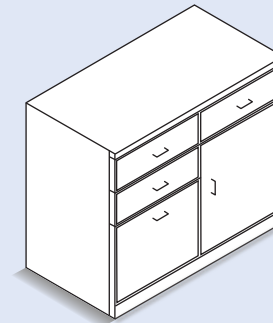

SIDE STORAGE : 4 DRAWERS
1 SHUTTER

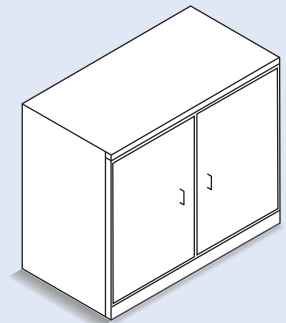

SIDE STORAGE : 2 SHUTTERS

Back Storage + Wall mounted cabinet

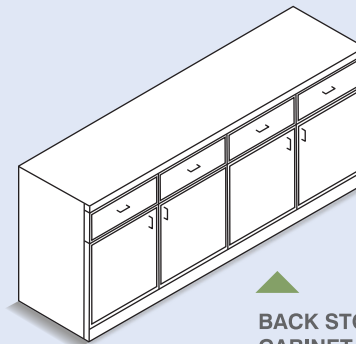

BACK STORAGE :
CABINET

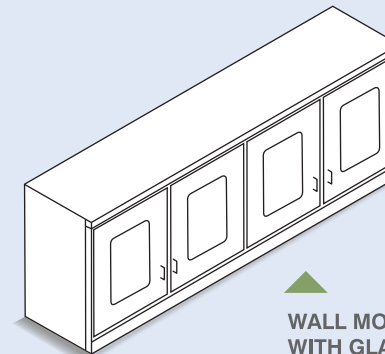

WALL MOUNTED CABINET
WITH GLASS DOOR



KEY BOARD TRAY



CPU STAND ON WHEELS



CABLE MANAGER



ELECTRICAL TRUNKING



INBUILT SWITCHES, SOCKETS,
LAN AND TELEPHONE CONNECTIONS

Accessories



GRANITE TABLE-TOP



BACK PAINTED TABLE-TOP



LAMINATED PLY TABLE-TOP

Table Top Options

Bunk Beds & Staff Lockers

Material of Construction : Mild steel
CRCA Sheet and ERW Tubes



BUNK BED WITHOUT STORAGE



BUNK BED WITH STORAGE



STAFF LOCKER
WITH SHOE SHELF



STAFF LOCKER



STAFF LOCKER
WITH HANGER ROD



CATHETER STORAGE



STENT STORAGE CABINET

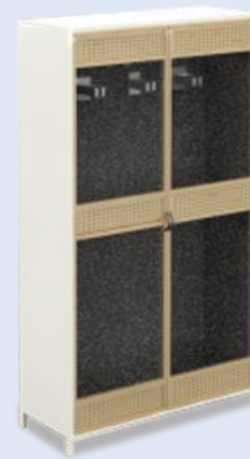

MS SCOPE CABINET



STENT STORAGE CABINET WITH DRAWERS



SS SCOPE CABINET



MS MANOMETRY TROLLEY

Cath Labs & Endoscopy unit furniture

Material of Construction : Mild steel
CRCA Sheet and ERW Tubes
Stainless Steel - 304 grade



CSSD : CONTROL AND
PACKAGING TABLE



CSSD : WORKTABLE WITH
TWO WASHING TRAYS



CSSD : WORKTABLE

CSSD Labs

Material of Construction :
Stainless Steel - 304 grade



CSSD : DRUM TROLLEY



CSSD : INSTRUMENT STAND

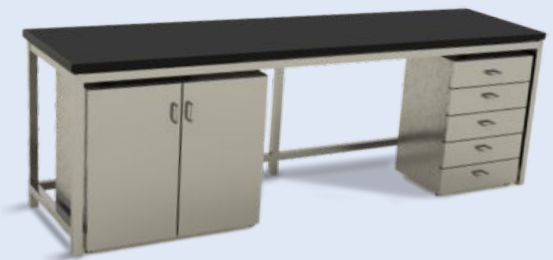

CSSD : WORKTABLE WITH
UNDER STORAGE CABINETS

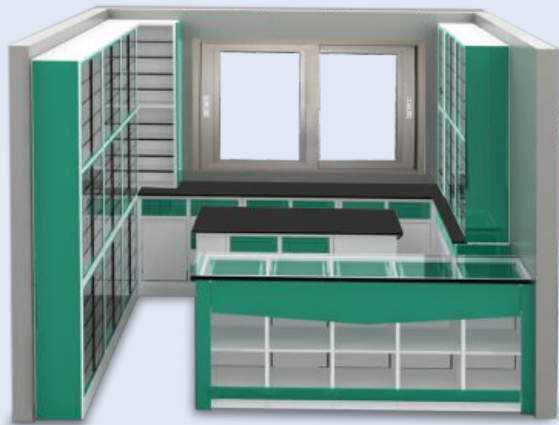

▲
**PHARMACY : RACK WITH
 GLASS SHELVES AND
 SLIDING GLASS DOORS**



▲
**PHARMACY : RACK WITH GLASS
 SHELVES+DRAWERS + SHUTTERS**

Pharmacy : Store Racks and Counters

Material of Construction :
 Mild steel CRCA Sheet
 and ERW Tubes



▲
**PHARMACY : OPEN RACK
 WITH SHELVES**



▲
**PHARMACY : RACK
 WITH SLIDING GLASS
 DOORS + DRAWERS**

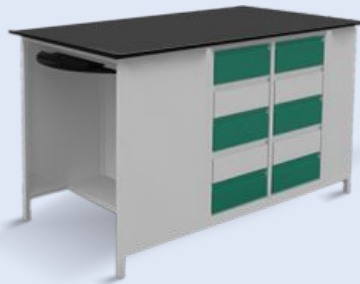

▲
**PHARMACY : ISLAND TABLE WITH
 DRAWERS + KNEE SPACE**

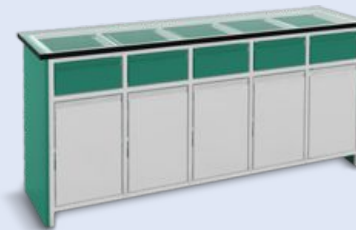
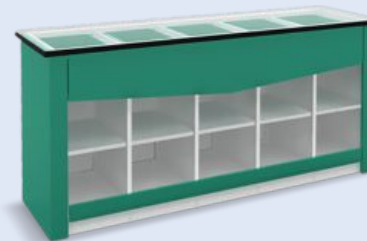

▲
**PHARMACY : MAIN COUNTER WITH
 DRAWERS + SHUTTERS**

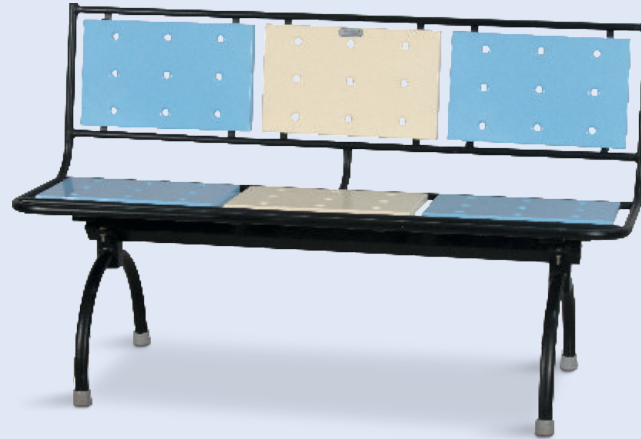

Mi : 3052 TWO-SEATER PATIENT WAITING BENCH (37" LENGTH)
 Mi : 3053 THREE-SEATER PATIENT WAITING BENCH (55" LENGTH)
 Mi : 3054 FOUR-SEATER PATIENT WAITING BENCH (72" LENGTH)

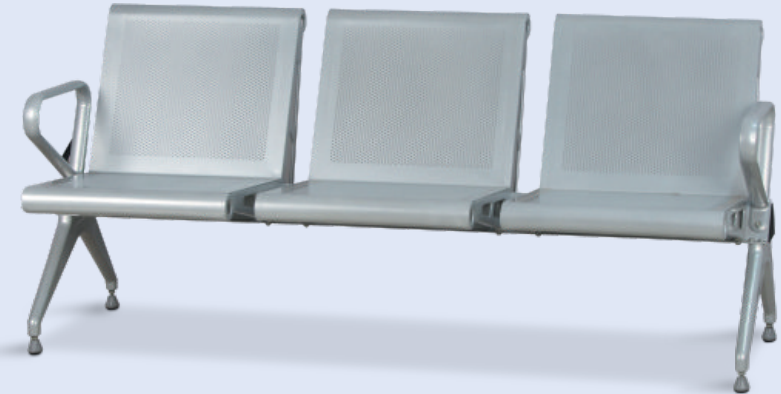

Mi : 3057 TWO-SEATER LOUNGE SEATING (48" LENGTH)
 Mi : 3056 THREE-SEATER LOUNGE SEATING (68" LENGTH)
 Mi : 3058 FOUR-SEATER LOUNGE SEATING (94" LENGTH)

Waiting Area Benches

Material of Construction :
 Mild steel CRCA Sheet and ERW Tubes



Mi : 3057 A TWO-SEATER LOUNGE SEATING WITH CUSHION (48" LENGTH)
 Mi : 3056 A THREE-SEATER LOUNGE SEATING WITH CUSHION (68" LENGTH)
 Mi : 3058 A FOUR-SEATER LOUNGE SEATING WITH CUSHION (96" LENGTH)



▲
MI-6098
POLYMER SEAT
STACKABLE CHAIR



▲
MI-6099 C
CUSHIONED SEAT
STACKABLE CHAIR



▲
MI-6099 B
MEDIUM BACK CUSHIONED
SEAT OFFICE CHAIR



▲
MI-6099 A
HIGH BACK CUSHIONED
SEAT OFFICE CHAIR



▲
MI-6099 E
ERGONOMIC MESH HIGH
BACK OFFICE CHAIR

Chairs

COLOR SCHEME

We offer an exciting array of powder coating color ranges that can match your interior theme. All CRCA surfaces undergo an 8 tank pretreatment process that provides excellent corrosion resistance

WOODEN COLORS:



SOLID COLORS:



BASE FRAME COLORS:



PRODUCT FEATURES

- Durable mild steel CRCA construction
- Pretreated and powder coated with epoxy paint
- Maintenance free soft closing hydraulic hinges
- Smooth drawer channels that sustain repeated operations
- High quality standard raw material
- Environment friendly with wooden effect aesthetics
- Customized designs with spectrum of vivid color schemes

Quality Policy

Medimek is committed towards a common goal of achieving total customer delight by driving its mission statement through

- ✓ Continually innovating and improving products that are user friendly
- ✓ Optimizing the productivity by introducing useful inputs in our activities
 - ✓ Offering prompt and effective after sales service
 - ✓ Providing need based training to people





Medimek Industries

Manufacturer and Exporter of Patient and Utility Furniture

Tel. : +91-251-2621124, 2621242 • Mobile : +91 8888200065 • Email : info@medimek.com
B / 50 - 53 Additional MIDC, Anand Nagar, Ambernath [E] 421506, Dist. Thane, Maharashtra, India

Certifications: ISO-9001 • ISO-14001 • ISO-13485 • ISO-45001 • ISO-50001 • CE Certificate